

30歳以上男子単

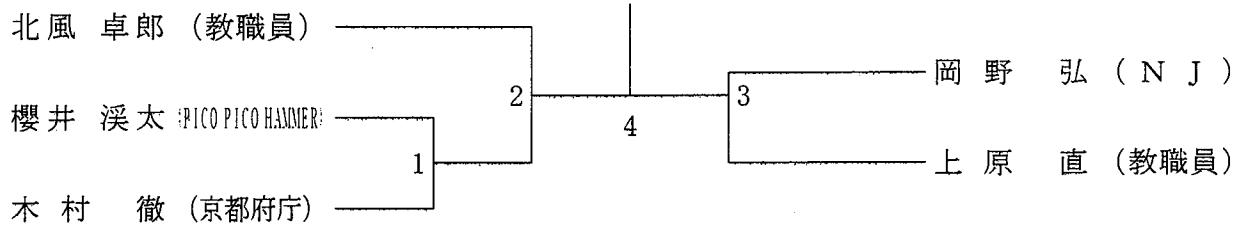

三位決定戦



35歳以上男子単

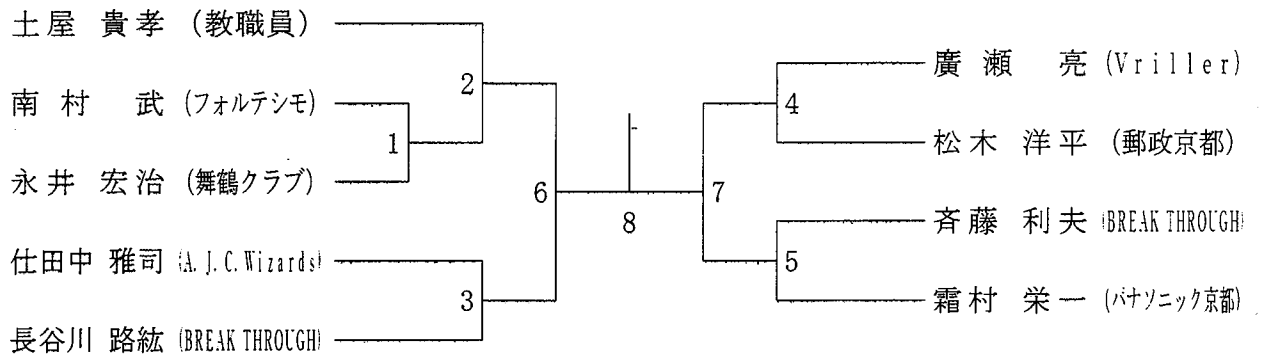

三位決定戦



40歳以上男子単

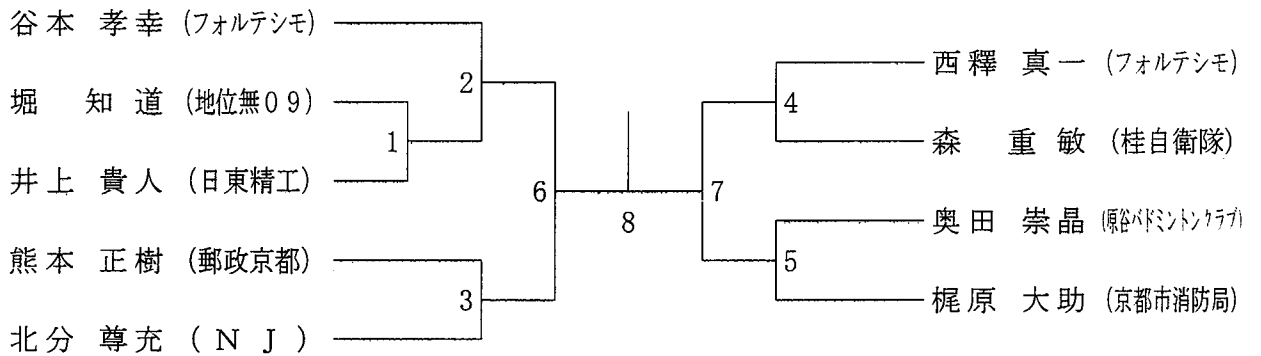

三位決定戦



45歳以上男子単

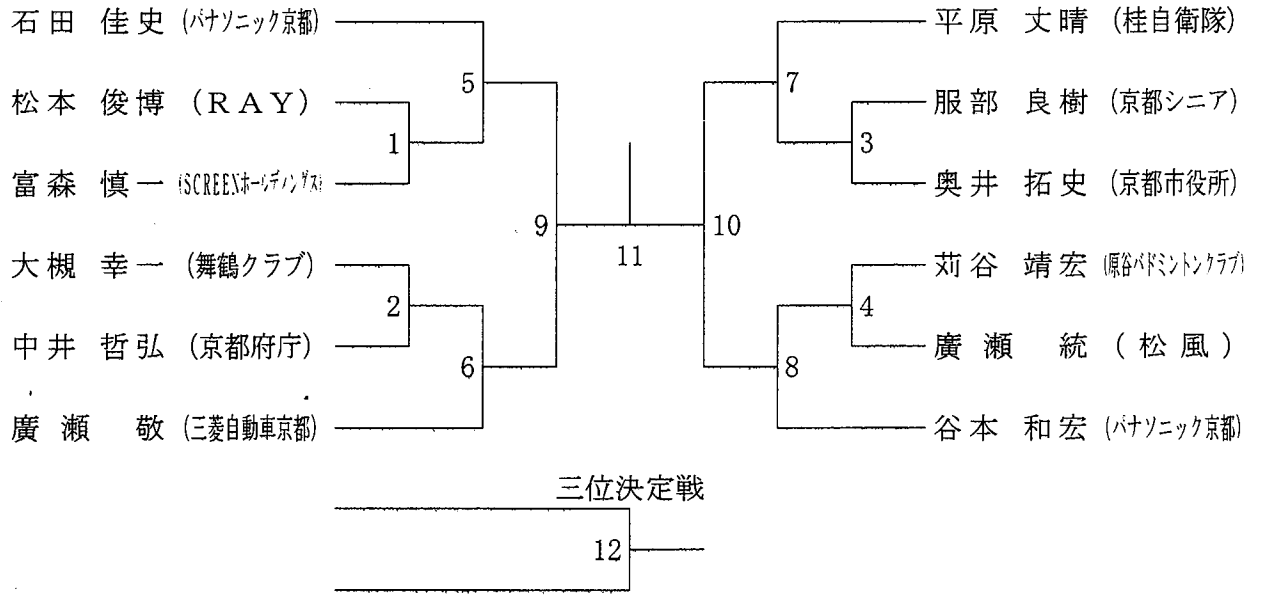

50歳以上男子単

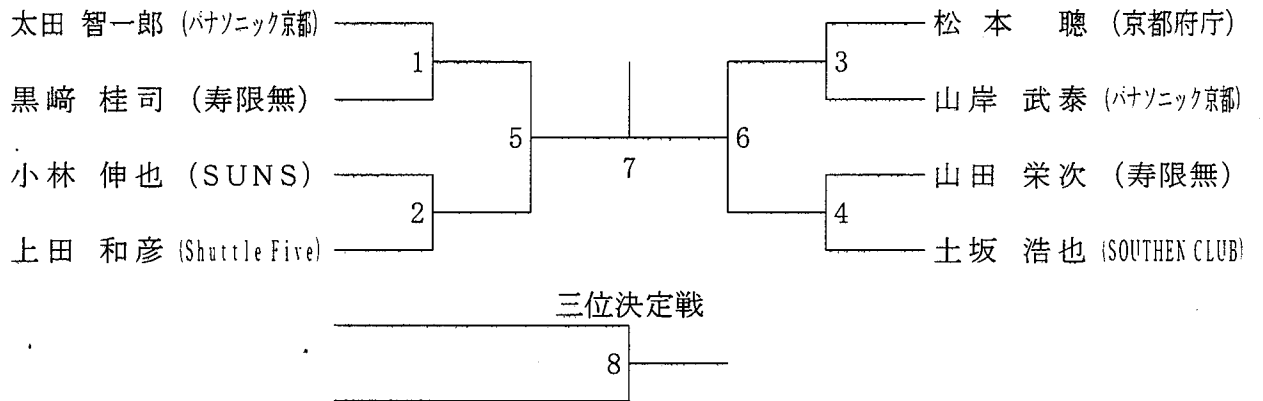

55歳以上男子単

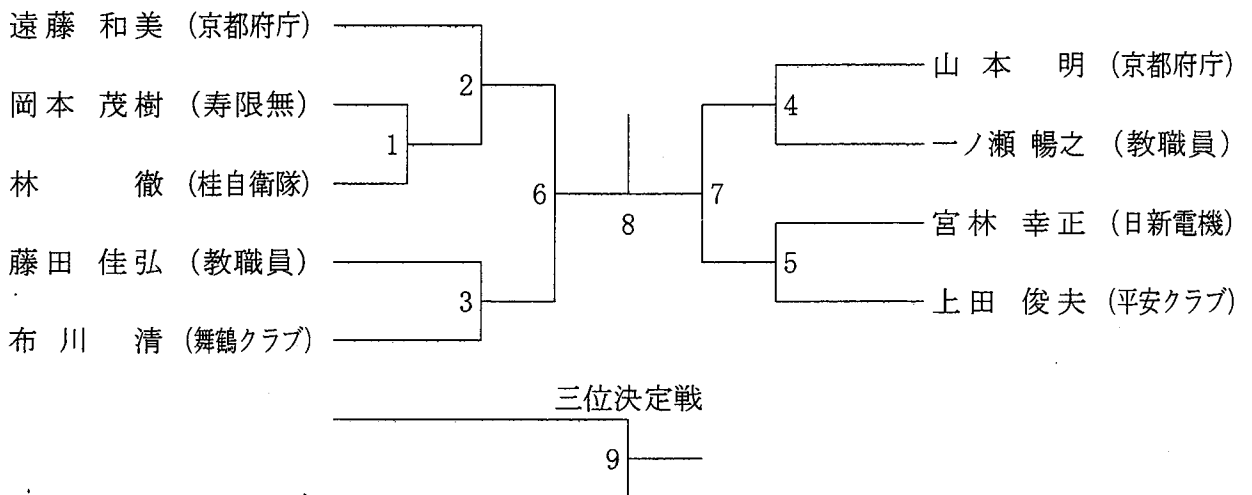

60歳以上男子単

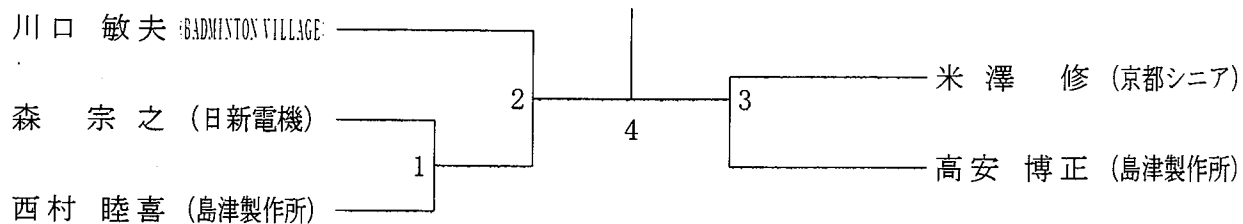

三位決定戦



65歳以上男子単

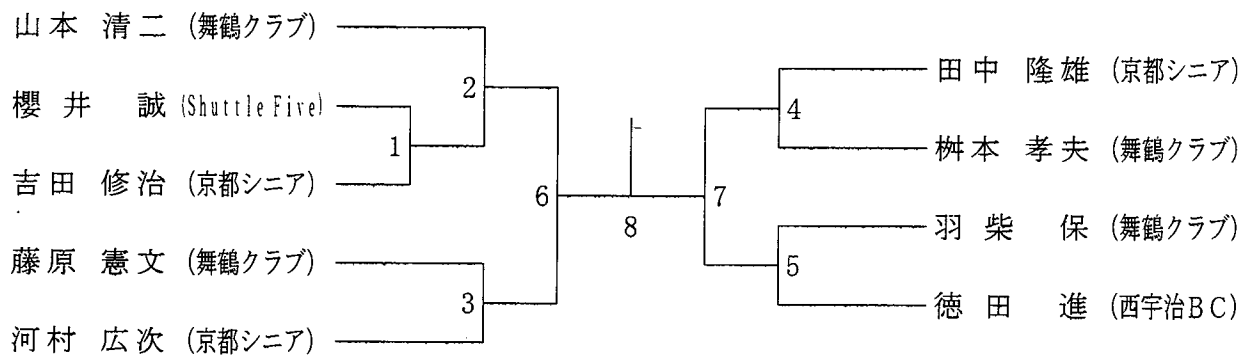

三位決定戦



70歳以上男子単

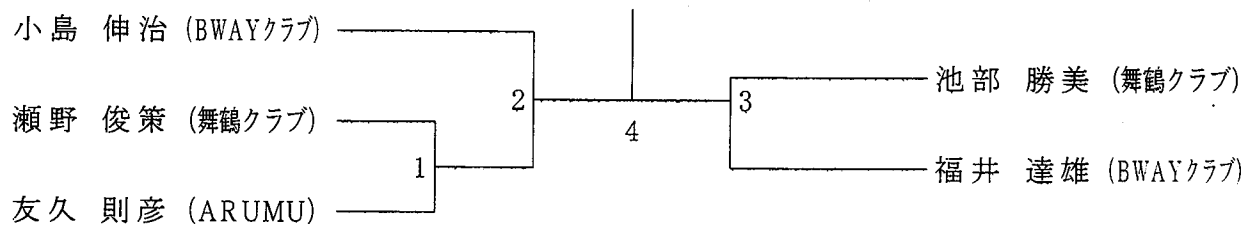

三位決定戦



30歳以上女子単

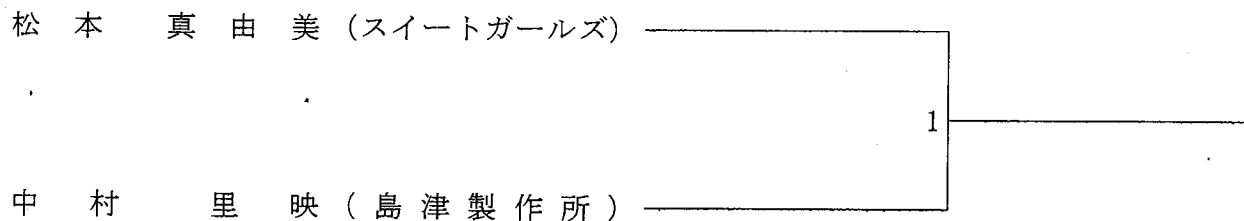

45歳以上女子単	小畑	竹田	板倉	勝敗	順位
小畑 真弓 (Vriller)		3	2		
竹田 友子 (N J)	3		1		
板倉 久美子 (常磐野)	2	1			

50歳以上女子単

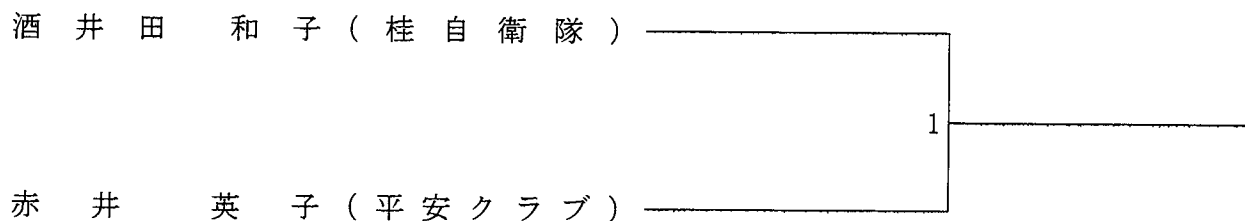

55歳以上女子単

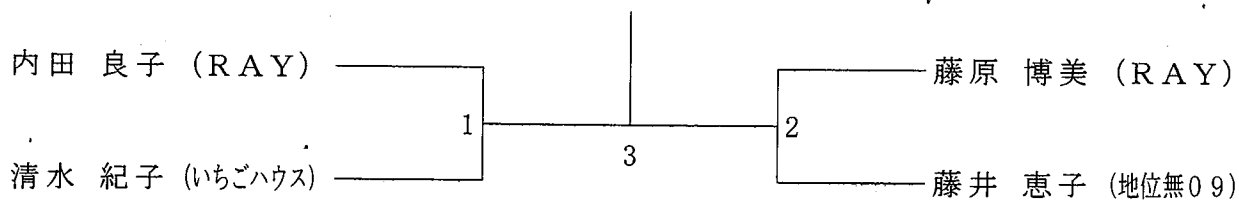

三位決定戦

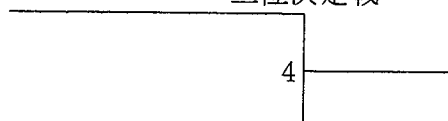

60歳以上女子単	小川	南村	安達	勝敗	順位
小川典子 (山鳩)		3	2		
南村益代 (つくし)	3		1		
安達真由美 (CloverZ)	2	1			

30歳以上男子複

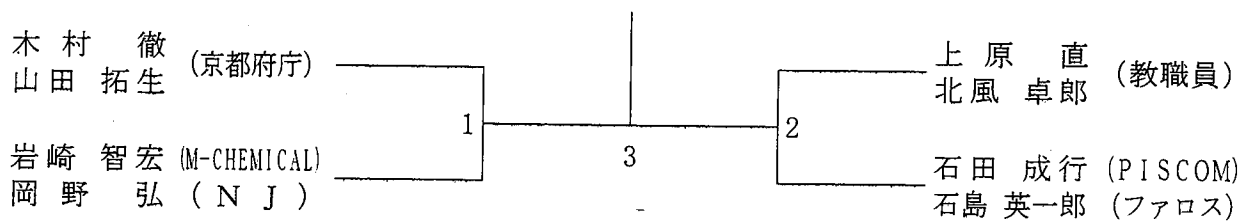

三位決定戦

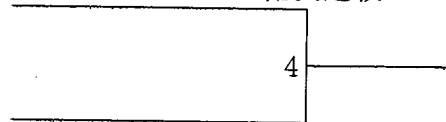

35歳以上男子複

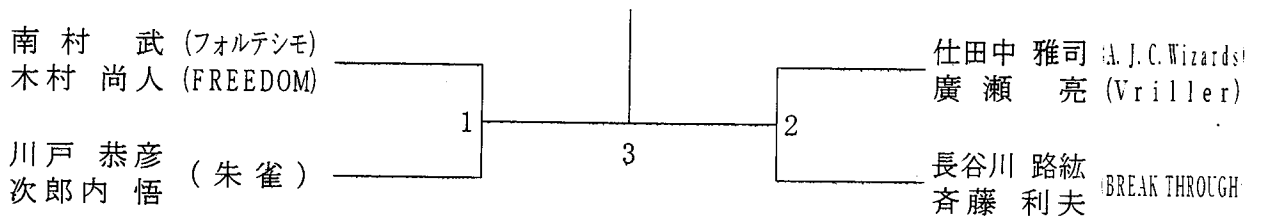

三位決定戦

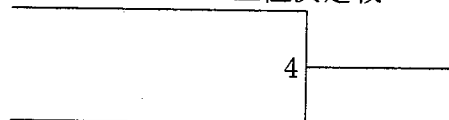

40歳以上男子複

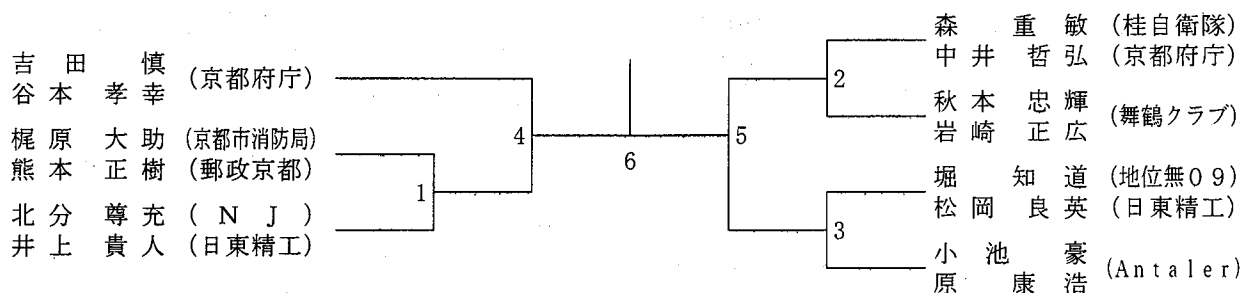

三位決定戦



45歳以上男子複

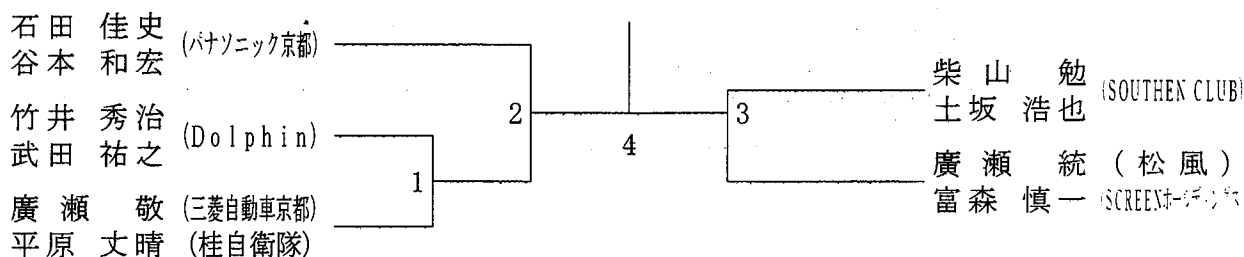

三位決定戦



50歳以上男子複

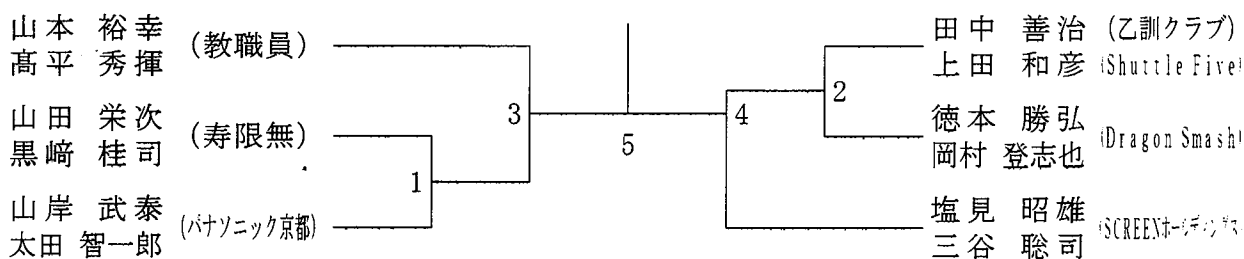

三位決定戦



55歳以上男子複

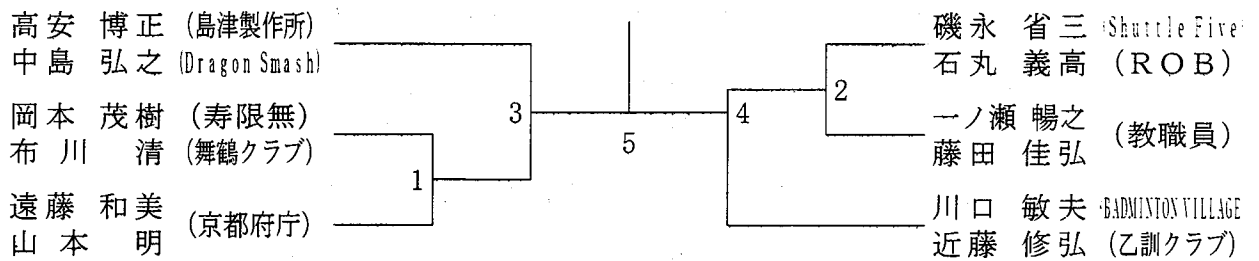

三位決定戦

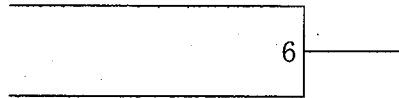

60歳以上男子複

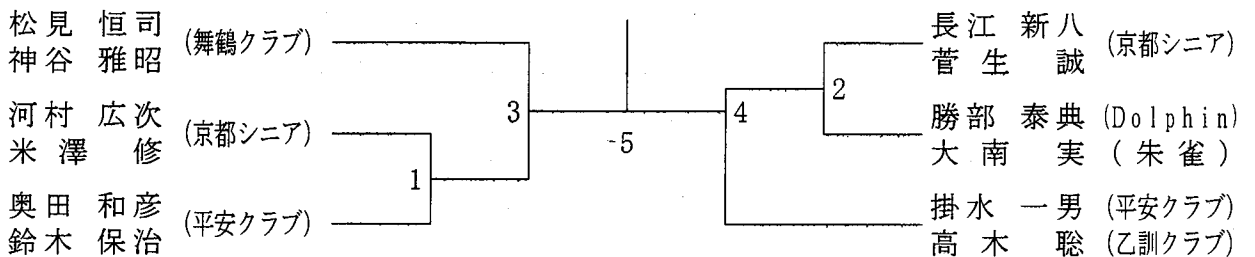

三位決定戦

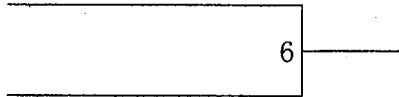

65歳以上男子複

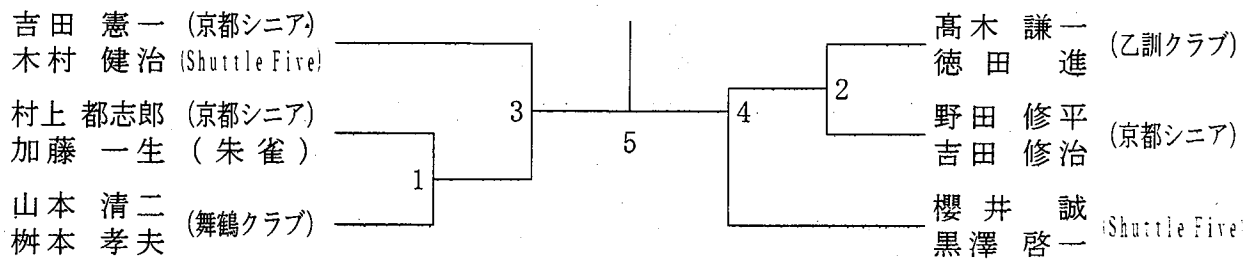

三位決定戦

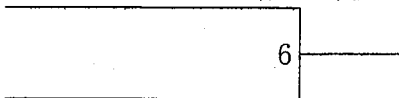

45歳以上女子複

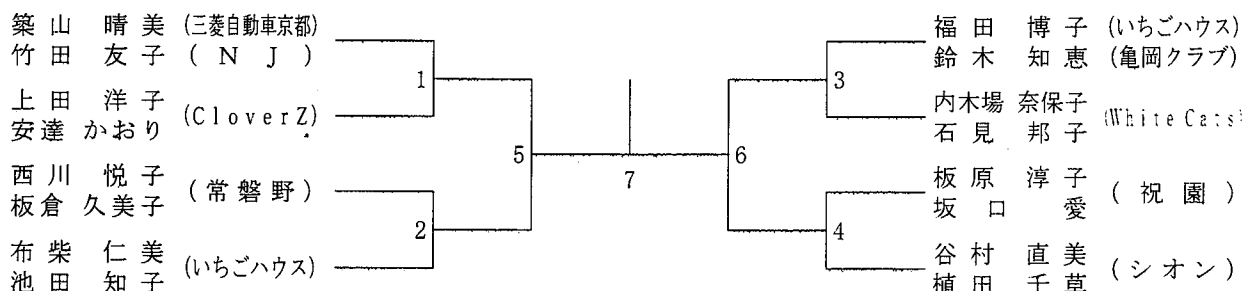

三位決定戦



50歳以上女子複

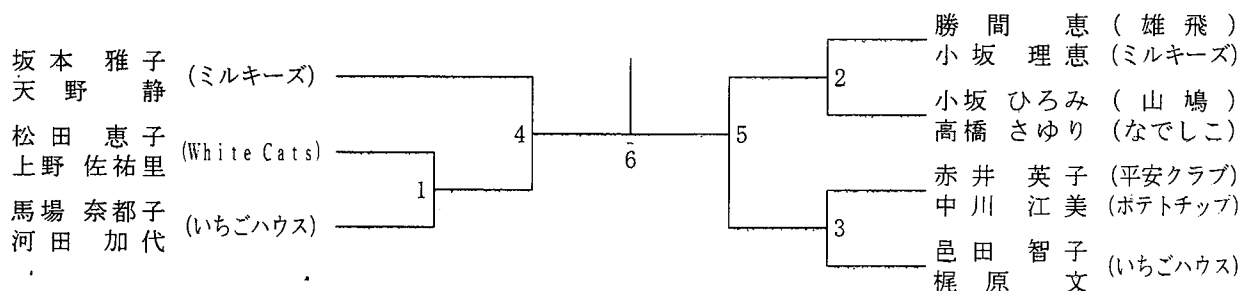

三位決定戦



55歳以上女子複

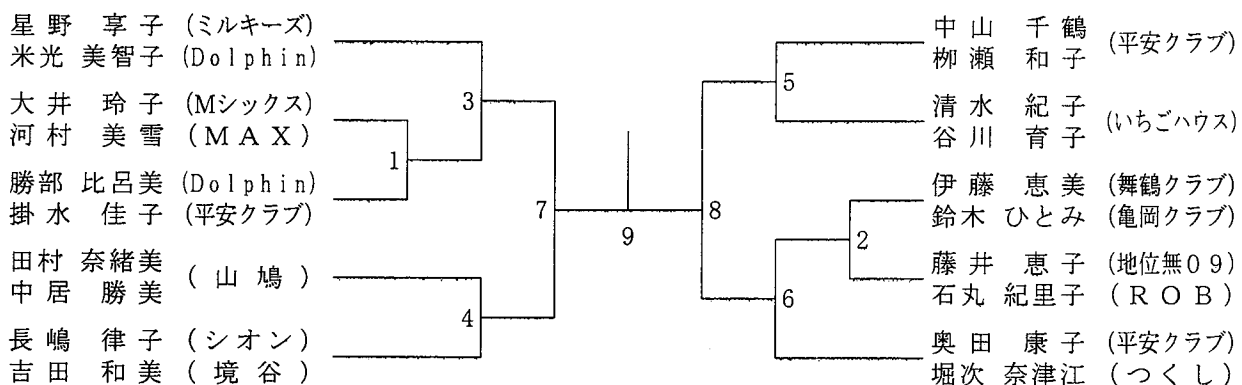

三位決定戦



60歳以上女子複

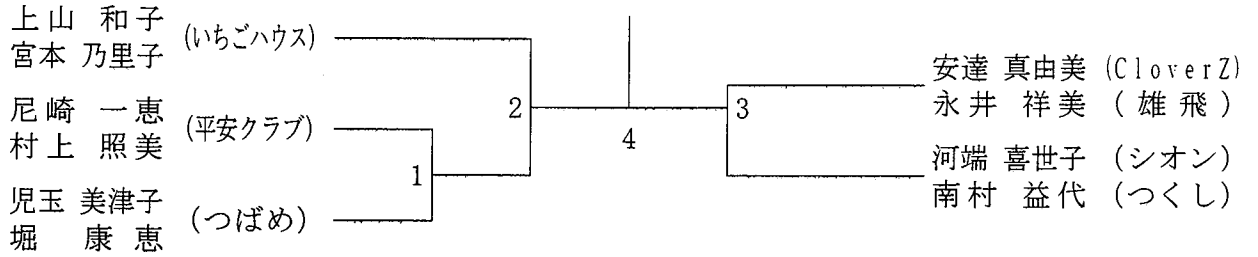

三位決定戦



30歳以上混合複

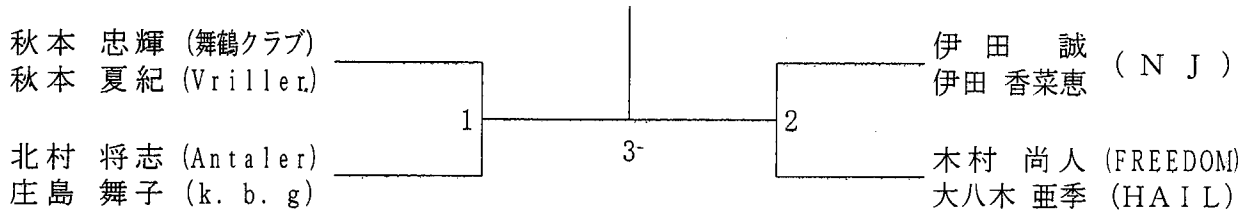

三位決定戦

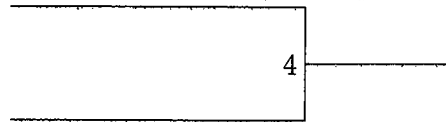

40歳以上混合複	吉田 慎 吉田 裕子	松岡 良英 上田 洋子	岡田 志 岡田 築	摩山 2 摩山 1	勝敗	順位
吉田 慎 (京都府庁) 吉田 裕子			3	2		
松岡 良英 (日東精工) 上田 洋子 (CloverZ)	3			1		
志摩 正人 (N J) 築山 晴美 (三菱自動車京都)	2	1				

45歳以上混合複	田西	中田	嶋田	田田	森大	森下	勝敗	順位
田中直樹 (Antaler)	/			3		2		
西田佳代子 (いちごハウス)								
嶋田剛 (N J)		3	/			1		
嶋田容子 (亀岡クラブ)								
森幹 (FREEDOM)		2		1	/			
大下令子 (Dolphin)								

50歳以上混合複

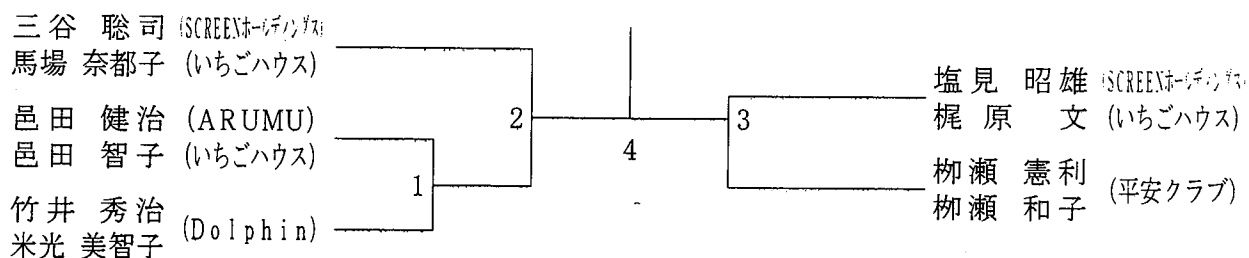

三位決定戦

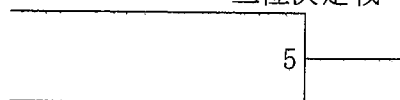

55歳以上混合複

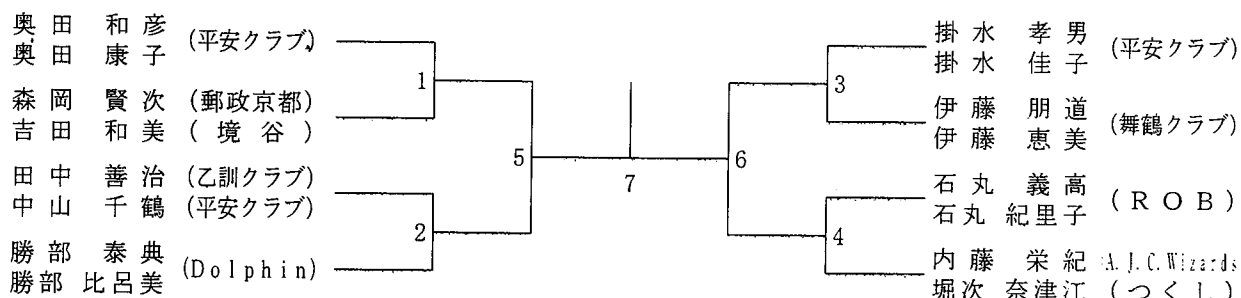

三位決定戦



60歳以上混合複

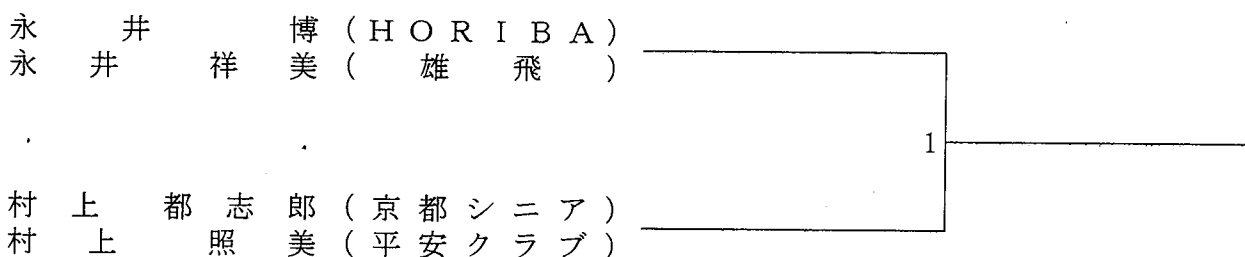

65歳以上混合複

